



Cleanness by Purpose

Various Connections, Wide Range Line-up!

ZD ▪ ZC Series

**Excellent Cracking Characteristics,  
Corresponding to Various Connections!**



# C

# heck Valves

Check valves made stainless steel

***IHARA SCIENCE CORPORATION***

## Table of Contents

Page	Contents
1	Features & Specification
2	Material/Flow Characteristic
3	Dimension Sheet, ZD Series(Half Union)
4	Dimension Sheet, ZD Series(Half Union/Union)
5	Dimension Sheet, ZD Series(Half Union/Nipple/Soket)
6	Dimension Sheet, ZD/ZC Series
7	Example of Custom Products

## Features

- Compact and Light
- Applicable fluid : Water, Air, Gas(N2)
- Range of Working Temperature : 0°C~200°C(Fluro-rubber)
  - \* When operating initially, try to move the poppet once, before putting into operation, as the O-ring may be close contact.
- Max Working Pressure : 5 MPa
- Wide selection, Easy choice, Standardized Half union type
  - \* BI-LOK connection : 1/4OD 3/8OD 1/2OD  $\phi$  6  $\phi$  8  $\phi$  10  $\phi$  12
  - \* Screwed connection(R, NPT) : 1/8 1/4 3/8 1/2
  - \* We will be corresponduing to the different shape and dimension from this catalogue, please inquire us regardless of quantity.

### Cracking Features

Pressure			Product label	※
PSIG	Kpa	Mpa		
1/3	1.96	0.003	2KPa	2
1	6.86	0.007	7KPa	7
10	68.6	0.069	70KPa	70

- \* Cracking pressure other than those listed above will be considered.
- \* In case of lower cracking pressure than 10KPa, the reverse pressure might be necessary, to re-seal of poppet

### Reverse pressure is as below

Size	Necessary reverse pressure
$\geq$ (1/4OD or 1/4 or $\phi$ 6)	Over 40KPa
1/4OD or 1/4 or $\phi$ 6 <	Over 60KPa

**Part Name and Material**

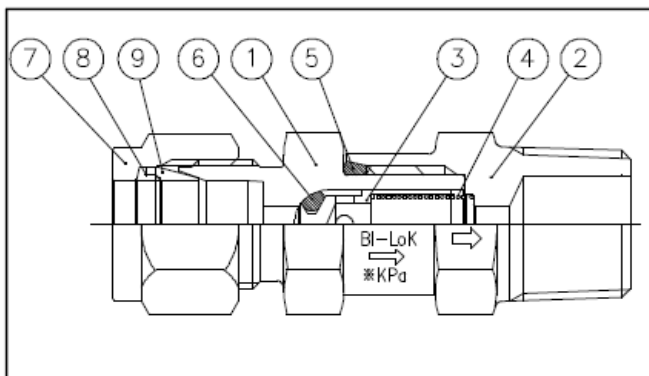

No	Part Name	Material
①	Body A	SUS316
②	Body B	SUS316
③	Poppet	SUS316
④	Spring	SUS316
⑤	O-ring	Fluro-rubber
⑥	O-ring	Fluro-rubber
⑦	Nut	SUS316
⑧	Front ferrule	SUS316
⑨	Back ferrule	SUS316

**Graph of Flow rate Characteristic per Craking Pressure**

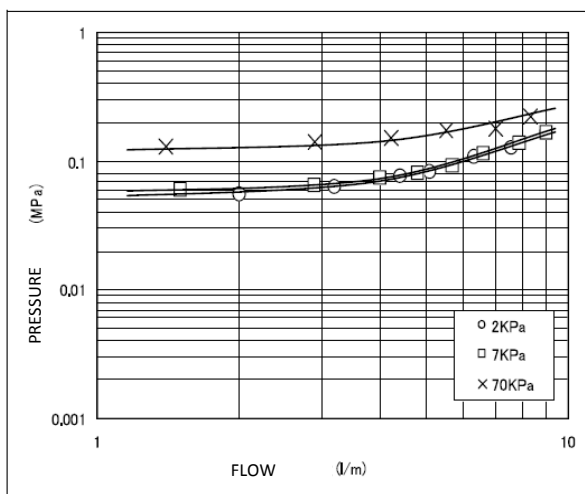

● BILOK1/4xR1/4

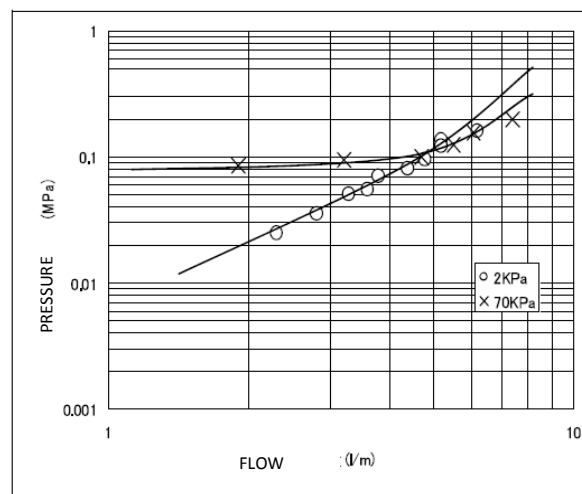

● BILOK1/4

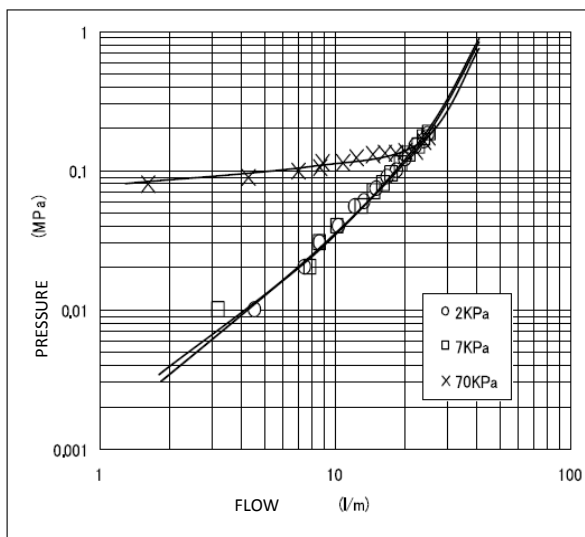

● BILOK3/8

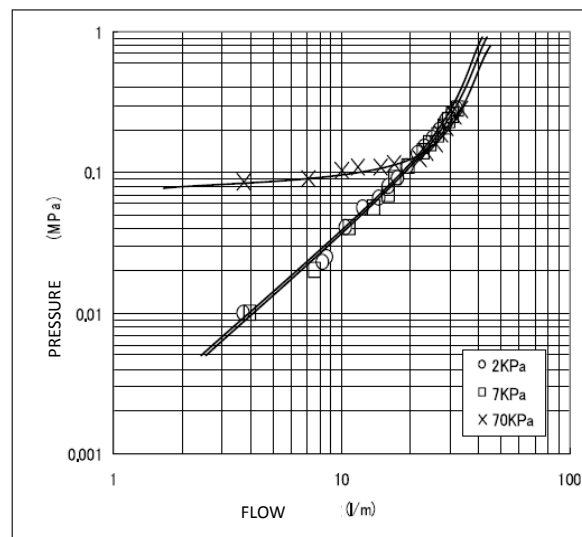

● BILOK1/2

CHECK VALVE ZD SERIES

● HALF UNION

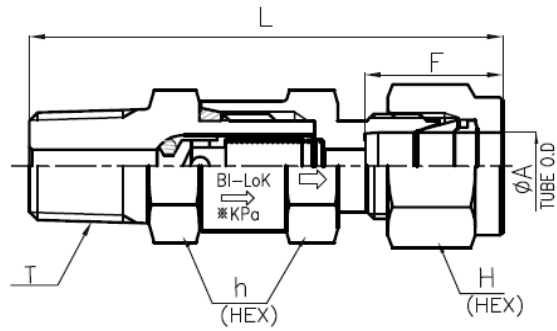

FLOW	Part No	[IN] T	[OUT] $\phi A$	h		H		F	L	
		R	INCH	MM	INCH	MM	INCH			MM
R → INCH BILOK	ZD-2RM4D-S-※KPa	1/8	1/4	6.35	5/8	15.88	9/16	14.29	15.4	50.5
	ZD-4RM2D-S-※KPa	1/4	1/8	3.18	5/8	15.88	1/2	12.7	13.0	52.4
	ZD-4RM4D-S-※KPa	1/4	1/4	6.35	5/8	15.88	9/16	14.29	15.4	54.0
	ZD-6RM6D-S-※KPa	3/8	3/8	9.53	15/16	23.81	11/16	17.46	17.0	72.2
	ZD-8RM8D-S-※KPa	1/2	1/2	12.7	15/16	23.81	7/8	22.23	23.0	80.1
R → M BILOK	ZD-2RM6MD-S-※KPa	1/8	—	6	—	17	—	14	15.4	50.2
	ZD-4RM6MD-S-※KPa	1/4	—	6	—	17	—	14	15.4	54.5
	ZD-4RM8MD-S-※KPa	1/4	—	8	—	17	—	17	16.3	55.7
	ZD-4RM10MD-S-※KPa	1/4	—	10	—	24	—	19	17.3	73.2
	ZD-6RM12MD-S-※KPa	3/8	—	12	—	24	—	22	22.9	80.4
	ZD-8RM12MD-S-※KPa	1/2	—	12	—	24	—	22	22.9	84.4

FLOW	Part No	[IN] T	[OUT] $\phi A$	h		H		F	L	
		NPT	INCH	MM	INCH	MM	INCH			MM
NPT → INCH BILOK	ZD-2NM4D-S-※KPa	1/8	1/4	6.35	5/8	15.88	9/16	14.29	15.4	50.5
	ZD-4NM4D-S-※KPa	1/4	1/4	6.35	5/8	15.88	9/16	14.29	15.4	54.0
	ZD-6NM4D-S-※KPa	3/8	1/4	6.35	11/16	17.46	9/16	14.29	15.4	54.0
	ZD-6NM6D-S-※KPa	3/8	3/8	9.53	15/16	23.81	11/16	17.46	17.0	72.2
	ZD-8NM8D-S-※KPa	1/2	1/2	12.7	15/16	23.81	7/8	22.23	23.0	79.6
NPT → M BILOK	ZD-2NM6MD-S-※KPa	1/8	—	6	—	17	—	14	15.4	50.2
	ZD-4NM6MD-S-※KPa	1/4	—	6	—	17	—	14	15.4	54.5
	ZD-4NM8MD-S-※KPa	1/4	—	8	—	17	—	17	16.3	55.7
	ZD-6NM12MD-S-※KPa	3/8	—	12	—	24	—	22	22.9	80.4
	ZD-8NM12MD-S-※KPa	1/2	—	12	—	24	—	22	22.9	84.4

CHECK VALVE ZD SERIES

● HALF UNION

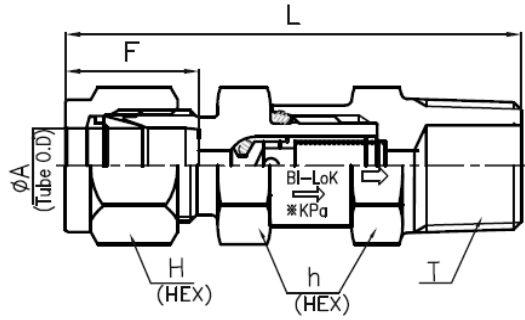

FLOW	Part No	[IN] $\phi A$		[OUT] T	h		H		F	L
		INCH	MM	R	INCH	MM	INCH	MM	MM	MM
INCH-BILOK → R	ZD-4D2RM-S-*KPa	1/4	6.35	1/8	5/8	15.88	9/16	14.29	15.4	50.5
	ZD-4D4RM-S-*KPa	1/4	6.35	1/4	5/8	15.88	9/16	14.29	15.4	55.0
	ZD-4D6RM-S-*KPa	1/4	6.35	3/8	11/16	17.46	9/16	14.29	15.4	55.9
	ZD-6D4RM-S-*KPa	3/8	9.53	1/4	15/16	23.81	11/16	17.46	17.0	71.2
	ZD-6D6RM-S-*KPa	3/8	9.53	3/8	15/16	23.81	11/16	17.46	17.0	72.2
	ZD-8D8RM-S-*KPa	1/2	12.7	1/2	15/16	23.81	7/8	22.23	23.0	79.6
M-BILOK → R	ZD-6MD4RM-S-*KPa	—	6	1/4	—	17	—	14	15.4	54.5
	ZD-8MD4RM-S-*KPa	—	8	1/4	—	17	—	17	16.3	55.7
	ZD-10MD6RM-S-*KPa	—	10	3/8	—	24	—	19	17.3	76.7
	ZD-12MD8RM-S-*KPa	—	12	1/2	—	24	—	22	22.9	80.7

● UNION

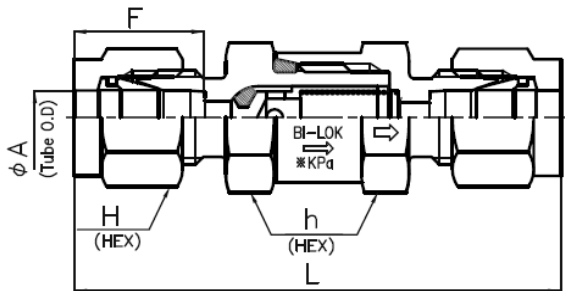

FLOW	Part No	[IN-OUT] $\phi A$		h		H		F	L
		INCH	MM	INCH	MM	INCH	MM	MM	MM
INCH-BILOK → INCH-BILOK	ZD-2D-S-*KPa	1/8	3.18	5/8	15.88	7/16	11.11	13.0	57.4
	ZD-4D-S-*KPa	1/4	6.35	5/8	15.88	9/16	14.29	15.4	59.1
	ZD-6D-S-*KPa	3/8	9.53	15/16	23.81	11/16	17.46	17.0	76.4
	ZD-8D-S-*KPa	1/2	12.7	15/16	23.81	7/8	22.23	23.0	82.1
M-BILOK → M-BILOK	ZD-6MD-S-*KPa	—	6	—	17	—	14	15.4	58.2
	ZD-8MD-S-*KPa	—	8	—	17	—	17	16.3	61.0
	ZD-10MD-S-*KPa	—	10	—	24	—	19	17.3	78.3
	ZD-12MD-S-*KPa	—	12	—	24	—	22	22.9	84.5

CHECK VALVE ZD SERIES

● HALF UNION

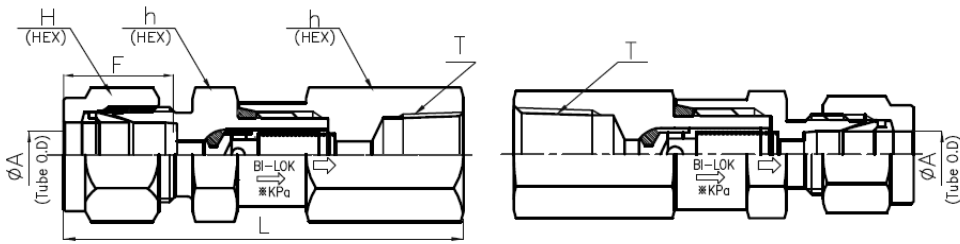

FLOW	Part No	[IN] φA		[OUT] T		h		H		F	L
		INCH	MM	Rc	INCH	MM	INCH	MM			
INCH-BILOK → Rc	ZD-4D4RF-S-※KPa	1/4	6.35	1/4	3/4	19.05	9/16	14.29	15.4	58.5	
	ZD-4D6RF-S-※KPa	1/4	6.35	3/8	7/8	22.23	9/16	14.29	15.4	59.5	
	ZD-6D4RF-S-※KPa	3/8	9.53	1/4	15/16	23.81	11/16	17.46	17.0	72.9	
	ZD-6D6RF-S-※KPa	3/8	9.53	3/8	15/16	23.81	11/16	17.46	17.0	74.4	
	ZD-8D6RF-S-※KPa	1/2	12.7	3/8	15/16	23.81	7/8	22.23	23.0	77.2	
	ZD-8D8RF-S-※KPa	1/2	12.7	1/2	1-1/16	26.99	7/8	22.23	23.0	82.7	

FLOW	Part No	[IN] T		[OUT] φA		h		H		F	L
		Rc	INCH	MM	INCH	MM	INCH	MM			
Rc → INCH-BILOK	ZD-4RF4D-S-※KPa	1/4	1/4	6.35	3/4	19.05	9/16	14.29	15.4	56.2	
	ZD-4RF6D-S-※KPa	1/4	3/8	9.53	15/16	23.81	11/16	17.46	17.0	71.7	
	ZD-6RF4D-S-※KPa	3/8	1/4	6.35	15/16	23.81	9/16	14.29	15.4	58.4	
	ZD-6RF6D-S-※KPa	3/8	3/8	9.53	15/16	23.81	11/16	17.46	17.0	73.9	
	ZD-8RF6D-S-※KPa	1/2	3/8	9.53	1-1/16	26.99	11/16	17.46	17.0	80.3	
	ZD-8RF8D-S-※KPa	1/2	1/2	12.7	1-1/16	26.99	7/8	22.23	23.0	84.2	

● NIPPLE

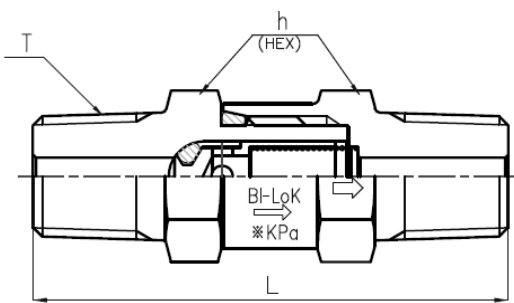

FLOW	Part No	[IN-OUT] T		h	L
		R	MM		
R → R	ZD-2RM-S-※KPa	1/8	17	42.5	
	ZD-4RM-S-※KPa	1/4	17	50.5	
	ZD-6RM-S-※KPa	3/8	24	69.0	
	ZD-8RM-S-※KPa	1/2	24	76.0	

● SOKET

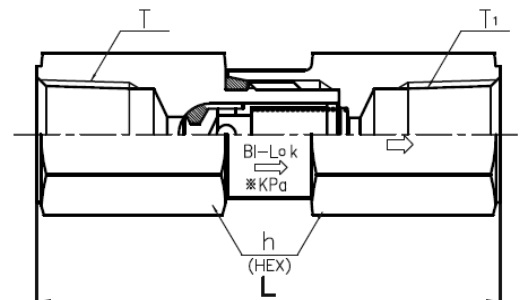

FLOW	Part No	[IN-OUT] T		h	L
		Rc	MM		
Rc → Rc	ZD-4RF-S-※KPa	1/4	17	54.5	
	ZD-6RF-S-※KPa	3/8	24	71.0	
	ZD-8RF-S-※KPa	1/2	27	79.0	

FLOW	Part No	[IN-OUT] T		h	L
		NPT	MM		
NPT → NPT	ZD-4NF-S-※KPa	1/4	17	54.5	
	ZD-6NF-S-※KPa	3/8	24	71.0	
	ZD-8NF-S-※KPa	1/2	27	79.0	

● ADAPTER

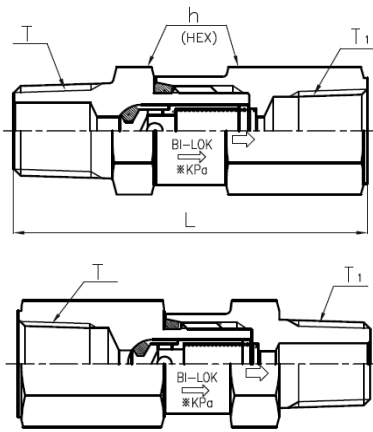

FLOW	Part No	[IN] T	[OUT] T <sub>1</sub>	F	L
		R	R <sub>c</sub>	MM	MM
R → R <sub>c</sub>	ZD-2RM2RF-S-※KPa	1/8	1/8	17	45.0
	ZD-4RM4RF-S-※KPa	1/4	1/4	17	52.5
	ZD-6RM6RF-S-※KPa	3/8	3/8	24	70.0
	ZD-8RM8RF-S-※KPa	1/2	1/2	27	78.0

FLOW	Part No	[IN] T	[OUT] T <sub>1</sub>	F	L
		R <sub>c</sub>	R	MM	MM
R <sub>c</sub> → R	ZD-2RF2RM-S-※KPa	1/8	1/8	17	45.0
	ZD-4RF4RM-S-※KPa	1/4	1/4	17	52.5
	ZD-6RF6RM-S-※KPa	3/8	3/8	24	70.0
	ZD-8RF8RM-S-※KPa	1/2	1/2	27	78.0

CHECK VALVE ZC SERIES

● COMPACT NIPPLE

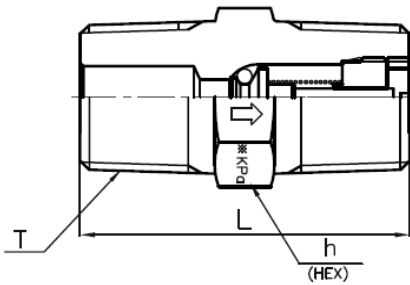

FLOW	Part No	[IN-OUT] T	F	L
		R	MM	MM
R → R	ZC-4RM-S-※KPa	1/4	17	36.0
	ZC-6RM-S-※KPa	3/8	19	38.0
	ZC-8RM-S-※KPa	1/2	24	50.0

FLOW	Part No	[IN-OUT] T	F	L
		NPT	MM	MM
NPT → NPT	ZC-4NM-S-※KPa	1/4	17	36.0
	ZC-6NM-S-※KPa	3/8	19	38.0

● COMPACT HALF UNION

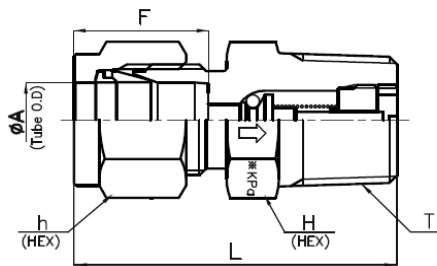

FLOW	Part No	[IN] φA		[OUT] T <sub>1</sub>	h		H		F	L
		INCH	MM	R	INCH	MM	INCH	MM	MM	MM
INCH-BILOK → R	ZC-4D4RM-S-※KPa	1/4	6.35	1/4	9/16	14.29	9/16	14.29	15.4	37.8
	ZC-4D6RM-S-※KPa	1/4	6.35	3/8	11/16	17.46	9/16	14.29	15.4	39.5
	ZC-6D4RM-S-※KPa	3/8	9.53	1/4	5/8	15.88	11/16	17.46	17.0	40.0
	ZC-6D6RM-S-※KPa	3/8	9.53	3/8	11/16	17.46	11/16	17.46	17.0	41.0
	ZC-8D8RM-S-※KPa	1/2	12.7	1/2	7/8	22.23	7/8	22.23	23.0	47.8
M-BILOK → R	ZC-6MD4RM-S-※KPa	—	6	1/4	—	17	—	14	15.4	40.2
	ZC-10MD4RM-S-※KPa	—	10	1/4	—	19	—	19	17.3	41.1
	ZC-12MD6RM-S-※KPa	—	12	3/8	—	22	—	22	22.9	44.5

CUSTOM PRODUCT ZD ZC SERIES

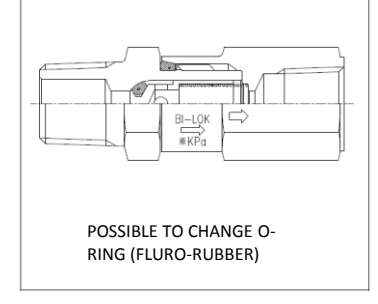
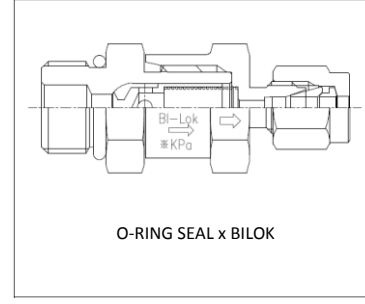
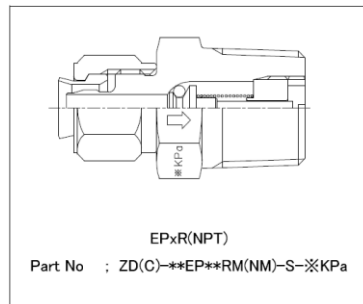
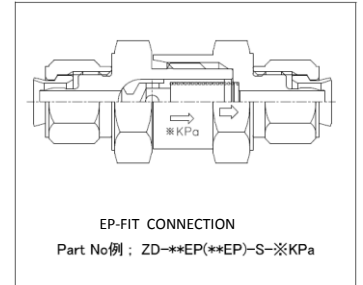
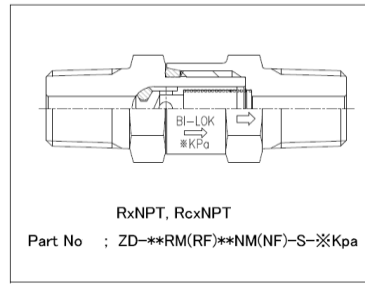
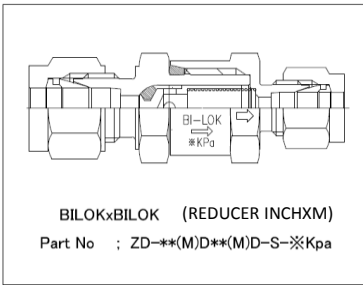

**WARNING:** If your don't select and handle fittings, valves and related accessories in an adequate manner, it may damage human beings and applicable systems. Within the responsibility and authorization of users and piping desiners, fittings, valves and related accessories shall be adequately selected, assembled, used and maintained based on the applicable conditions and product conformity to the system to be applied. Please read carefully our operation manual and feel free to contact with IHARA SCIENCE CORPORATION if you have any question of request.



*IHARA SCIENCE CORPORATION*

URL: <http://www.ihara-sc.co.jp>

Head office : 3-11-3, Takanawa, Minato-Ku, Tokyo, Japan 108-0074

Tel: +81-(0)3-6721-6981

Fax:+81-(0)3-6721-6991